

CAA-M BIMETALLIC CONNECTORS

copper palm fixing - aluminium barrels

Description:

- The barrels of series CAA-M connectors are made from aluminium of a purity equal to or greater than 99,5%. The cross sectional area of the annulus and the length of the barrel are designed to assure an extremely reliable electrical connection.
- The palm fixing is manufactured from electrolytic copper 99,90%.
- The barrel is friction welded to the palm thus achieving the best possible transition between the copper palm and aluminium barrel.
- The internal surface is duly protected against the oxidation through a specific grease with a very high dropping point.
- They are studied for connecting aluminium cable of low and medium voltage.

FEATURES OF THE MATERIAL		
PART	BARREL	PALM FIXING
DESIGNATION	Al 99.5	Cu ETP CW 0041A
STANDARD OF REFERENCE	UNI EN 573-3:2013	UNI EN 13601:2013
PARAMETERS		
ELECTRICAL RESISTANCE AT 20 °C ($\mu\Omega \cdot \text{cm}$)	2,874	1,724÷1,70
BREAKING RESISTANCE (N/mm ²)	85÷129	225
STRETCHING A5 %	10÷23	35

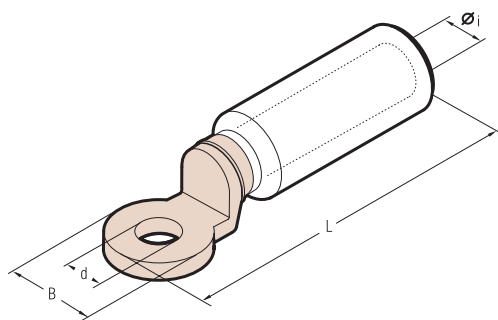
Sections and dimensions:

Conductor Size sqmm	Ø Stud mm	Ref.	Dimensions mm				Quantity Box/Bag
			Øi	B	L	d	
10	12	CAA 10-M 12	4,3	24,0	87,0	13,0	90/3
16	12	CAA 16-M 12	5,5	24,0	87,0	13,0	90/3
25	12	CAA 25-M 12	6,5	24,0	87,0	13,0	90/3
35	12	CAA 35-M 12	8,0	24,0	87,0	13,0	90/3
	12	CAA 35-20-M 12	8,0	24,0	87,0	13,0	60/3
50	12	CAA 50-M 12	9,0	24,0	87,0	13,0	60/3
70	12	CAA 70-M 12	11,0	24,0	87,0	13,0	60/3
95	12	CAA 95-M 12	12,5	24,0	87,0	13,0	60/3
120	12	CAA 120-M 12	13,7	31,0	111,0	13,0	30/3
150	12	CAA 150-M 12	15,5	31,0	111,0	13,0	30/3
185	12	CAA 185-M 12	17,0	35,0	116,0	13,0	24/3
240	12	CAA 240-M 12	19,5	35,0	116,0	13,0	18/3
	12	CAA 300-34 M 12	22,5	35,0	120,0	13,0	15/3
300	16	CAA 300-34 M 16	22,5	35,0	120,0	17,0	15/3
	16	CAA 300-M 16	23,3	35,0	152,5	16,5	12/3
400	16	CAA 400-M 16	26,0	35,0	152,5	16,5	12/3
500	16	CAA 500-M 16 TNBD	29,1	35,0	152,5	16,5	12/3
630	8	CAA 630-4 M 8	32,5	60,0	192,0	4 x 9,0*	9/3

* n° 4 holes with 30 mm as distance between axes

Cembre SpA

Via Serenissima, 9 - 25135 Brescia (Italy)

Tel.: +39 030 36921 - Fax: +39 030 3365766

Web: www.cembre.com - Email: info@cembre.com